

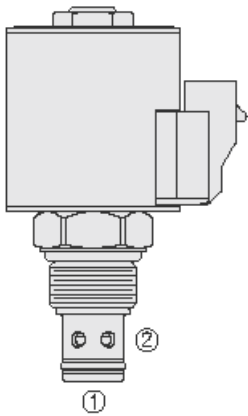

Overview



Description

The hsp10-20xx is a high pressure 2-way, piloted, poppet-type, proportional, normally closed screw-in hydraulic cartridge valve designed for low leakage blocking in load holding applications.

Operation

When de-energized, the hsp10-20xx blocks flow from ports 2 to 1. In this mode the cartridge will allow flow from ports 1 to 2 after overcoming the spring forces (see performance graph). When energized, the valve will allow flow proportional to the applied current from ports 2 to 1 while severely restricting flow from ports 1 to 2. Manual override m - option: for normal operation (de-energized) the manual override pin must be seated in the lower detent groove. To shift the valve manually, the operator pushes down on the knob and rotates 180 degrees in either direction. When the manual override is actuated, increased flow CAN be achieved by pulling on the knob. Manual override t - option: for normal operation (de-energized) the manual override button must be fully rotated clockwise. To shift the valve manually, rotate the manual override button counter-clockwise. Note: the manual override features is intended for emergency use, not for continuous-duty operation.

Symbol

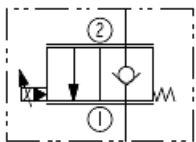

Features

- Low leakage.
- Continuous-duty rated coil.
- Efficient wet-armature construction.
- Waterproof E-Coils rated up to IP69K.
- Manual override and linear metering options.
- All HyPerformance[®] products are tested to NFPA specification T2.6.1.
- and are tested at a verification level of 90% and an assurance of 99%.

Ratings

Pressure Ratings

Pressure rating	350 bar (5075 psi)	
	420 bar (6090 psi)	- Note: (10% cycle life)
Proof pressure	690 bar (10000 psi)	
Burst pressure	1380 bar (20000 psi)	

Flow Ratings

Flow rating	50.3 lpm (13.3 gpm)	- Note: HSP10-20
	57.5 lpm (15.2 gpm)	- Note: HSP10-20A with compensation 11.0 bar (160 psi)
	34.1 lpm (9 gpm)	- Note: With compensation 5.5 bar (80 psi)
Maximum internal leakage	5 drops/min	- Note: With 350 bar (5075 psi) at port 2

Other Ratings

Cycle life	One million cycles
------------	--------------------

Temperature Ratings

Operating fluid temperature	-40 to 100 °C (-40 to 212 °F)	- Note: With buna N seals
	-26 to 204 °C (-15 to 400 °F)	- Note: With fluorocarbon seals
	-54 to 107 °C (-65 to 225 °F)	- Note: With urethane seals
Storage temperature	-40 to 70 °C (-40 to 160 °F)	
Ambient temperature	-40 to 90 °C (-40 to 194 °F)	

Operating Parameters

Fluids	Mineral based or synthetic hydraulic fluid with lubricating properties
Fluid viscosity range	7.4 to 420 cSt
Maximum operating contamination level	18/16/13 per ISO 4406



Properties

Unit weight 0.18 kg (0.4 lb) - **Note:** (without coil and nut)
 Internal wetted surface area 137.29 cm² (21.28 in²)

Performance

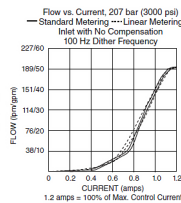
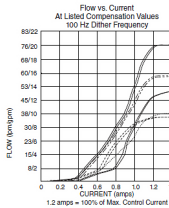
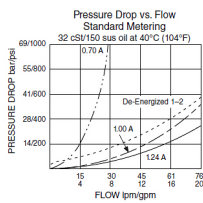
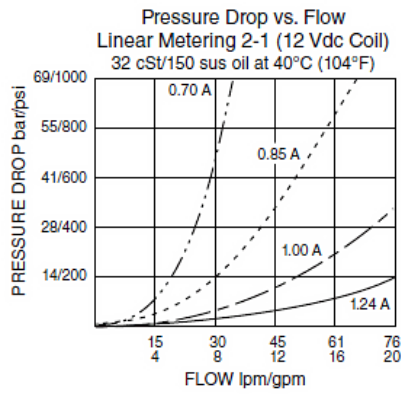
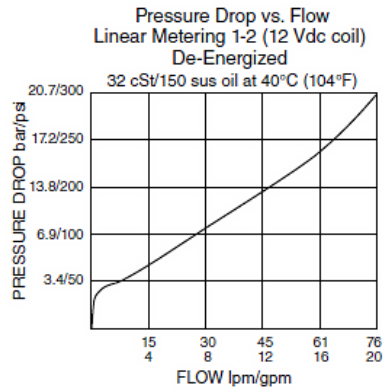

Dimensions

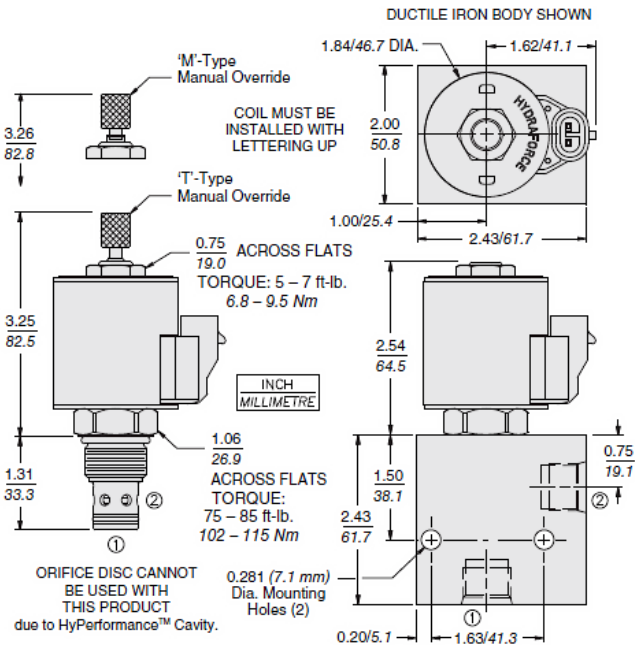

Installation Specifications

Cavity HVC10-2
 Cartridge installation torque 102 to 115 N-m (75 to 85 ft-lb) - **Note:** Steel/ductile iron cavity
 81 to 88 N-m (60 to 65 ft-lb) - **Note:** Aluminum cavity
 Orientation restriction None



Accessories

Seal kit	SK10-2N-M	- Note: Buna N
	SK10-2V-M	- Note: Fluorocarbon
	SK10-2U-0	- Note: Urethane

Order Code

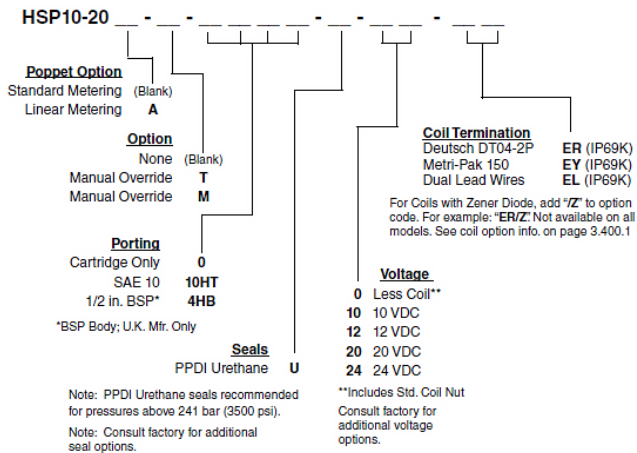

Model Options

HSP10-20DE-H-J-L

D Poppet Metering

CODE	DESCRIPTION
A	Linear Poppet Metering
BLANK	Standard Poppet Metering

E Manual Override

CODE	DESCRIPTION
BLANK	NONE
M	Two Position Override, Red Knurled Knob
T	Variable Position Override, Red Knurled Knob

H Line Body

CODE	DESCRIPTION
0	No Body

J Seal

CODE	DESCRIPTION
N	Buna-N
V	Fluorocarbon
U	PPDI Urethane

L Coil

CODE	DESCRIPTION
0	No Coil
10EL	10 VDC, E-Coil, Dual Lead Wires
10ER	10 VDC, E-Coil, Deutsch
12EG	12 VDC, E-Coil, DIN 43650
12EJ	12 VDC, E-Coil, AMP Jr.
12EL	12 VDC, E-Coil, Dual Lead Wires, 18 inches long



CODE	DESCRIPTION
12EL/36	12 VDC, E-Coil, Dual Lead Wires, 36 inches long
12ER	12 VDC, E-Coil, Deutsch
12EY	12 VDC, E-Coil, Metri-Pack 150
20ER	20 VDC, E-Coil, Deutsch
24EG	24 VDC, E-Coil, DIN 43650
24EJ	24 VDC, E-Coil, AMP Jr.
24EL	24 VDC, E-Coil, Dual Lead Wires, 18 inches long
24EL/36	24 VDC, E-Coil, Dual Lead Wires, 36 inches long
24ER	24 VDC, E-Coil, Deutsch
24EY	24 VDC, E-Coil, Metri-Pack 150