

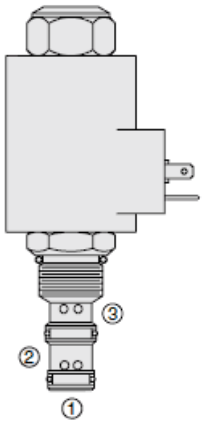

Overview



Description

The PV70-30 is a solenoid operated, pressure compensated, spool type, normally closed, priority type proportional flow control regulator. It also CAN be used as a restrictive type, 2-way, pressure compensated proportional flow regulator (with port 2 blocked).

Operation

With inlet flow at port 1 the valve will regulate priority flow out of port 3 regardless of system working pressure with flow rate proportional to current applied to the solenoid. The excessive flow will bypass out of port 2. The bypass flow CAN be used for auxiliary function control. Note: avoid dead heading of priority line by external valving to prevent blocking of bypass line. In restrictive mode applications bypass port 2 has to be blocked, flow rate out of port 3 remains proportional to current applied to the solenoid regardless of load (pressure) applied to port 3.

Features

- Excellent linearity and hysteresis characteristics.
- Hardened spool and cage for long life.
- Optional coil voltages and terminations.
- Efficient wet-armature construction.
- Cartridges are voltage-interchangeable.
- Unitized, molded coil design.
- Coil waterproofing standard.
- Manual Override option.

Symbol

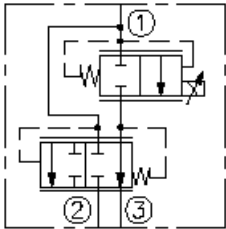

Ratings

Pressure Ratings

Pressure rating	241 bar (3500 psi)	- Note: Inlet
	207 bar (3000 psi)	- Note: Regulated (port3)
	207 bar (3000 psi)	
Proof pressure	345 bar (5000 psi)	
Burst pressure	896 bar (13000 psi)	

Flow Ratings

Flow rating	26.5 lpm (7.0 gpm)	- Note: Regulated, range a, 2-ported
	30.3 lpm (8.0 gpm)	- Note: Regulated, range a, 3-ported
	17.0 lpm (4.5 gpm)	- Note: Regulated, range b, 2-ported
	17.0 lpm (4.5 gpm)	- Note: Regulated, range b, 3-ported
	37.9 lpm (10.0 gpm)	- Note: Nominal input, range a, 3-ported
	18.9 lpm (5.0 gpm)	- Note: Nominal input, range b, 3-ported
Maximum internal leakage	49.2 lpm (13.0 gpm)	- Note: Maximum input, range a, 3-ported
	26.5 lpm (7.0 gpm)	- Note: Maximum input, range b, 3-ported
Maximum internal leakage	197 ml/min (12 in ³ /min)	- Note: At port 3 with at port 1 (port 2 closed) 207 bar (3000 in ³ /min)
Hysteresis per cent	%	- Note: Maximum, regulated flow range of 30-90%

Temperature Ratings

Operating fluid temperature	-40 to 100 °C (-40 to 212 °F)	- Note: With buna N seals
	-26 to 204 °C (-15 to 400 °F)	- Note: With fluorocarbon seals
	-54 to 107 °C (-65 to 225 °F)	- Note: With polyurethane seals
Storage temperature	-40 to 70 °C (-40 to 160 °F)	
Ambient temperature	-40 to 70 °C (-40 to 160 °F)	

Other Ratings

Corrosion protection	960 hr salt spray per ASTM b117
----------------------	---------------------------------



Operating Parameters

Fluids	Mineral based or synthetic hydraulic fluid with lubricating properties
Fluid viscosity range	7.4 to 420 cSt
Maximum operating contamination level	18/16/13 per ISO 4406

Properties

Unit weight	0.70 lb (0.32 kg) - Note: PV70-30X 0.8 lb (0.37 kg) - Note: Pv70-30mx 1.00 lb (0.45 kg) - Note: Pv70-30gx
Internal wetted surface area	202.2 cm ² (31.3 in ²) - Note: PV70-30X 205.5 cm ² (31.9 in ²) - Note: Pv70-30mx and pv70-30gx

Electrical Parameters

Note	(nominal values with size 70 e-series and d-series coil)	
Maximum control current	1500 mA - Note: Coil, flow range A 12 V 1350 mA - Note: Coil, flow range b 12 V 750 mA - Note: Coil, flow range A 24 V 675 mA - Note: Coil, flow range b 24 V	
Threshold current	335 mA - Note: Coil 12 V 165 mA - Note: Coil 24 V	
Valve inductance	240 mH - Note: E-coil 12 V 200 mH - Note: D-coil 12 V 700 mH - Note: E-coil 24 V 600 mH - Note: D-coil 24 V	
Dither PWM frequency	100 to 250 Hz	

Performance

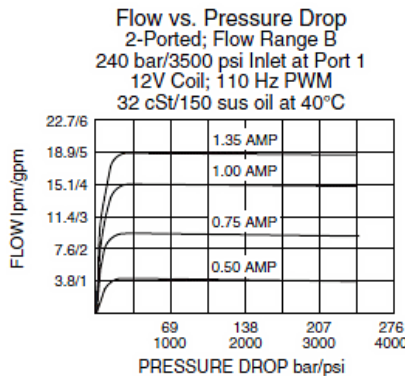
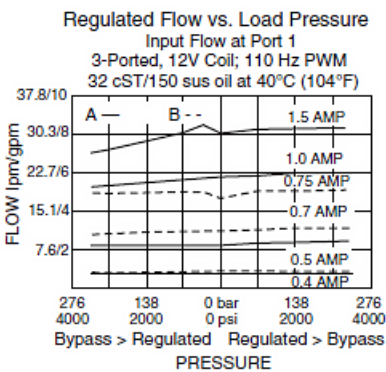
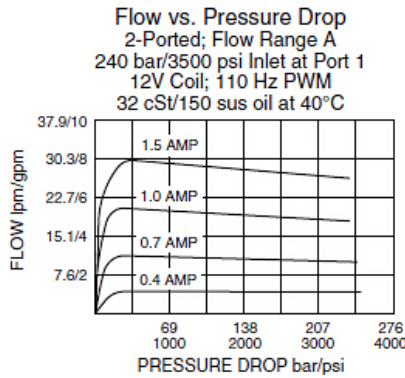
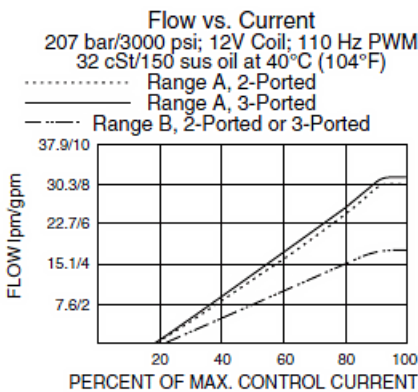



Dimensions

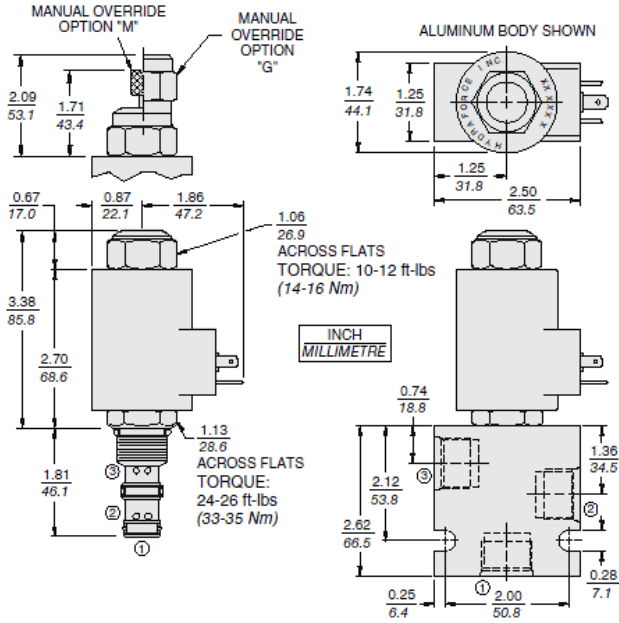

Installation Specifications

Cavity	VC10-3
Cartridge installation torque	33 to 35 N-m (24 to 26 ft-lb)
Maximum allowable torque	68 N-m (50 ft-lb)
Coil nut torque	14 to 16 N-m (10 to 12 ft-lb)
Cover cap torque	7 to 9 N-m (5 to 7 ft-lb)
Orientation restriction	None

Accessories

Seal kit SK10-3X-MM - **Note:** X = seal option

Order Code

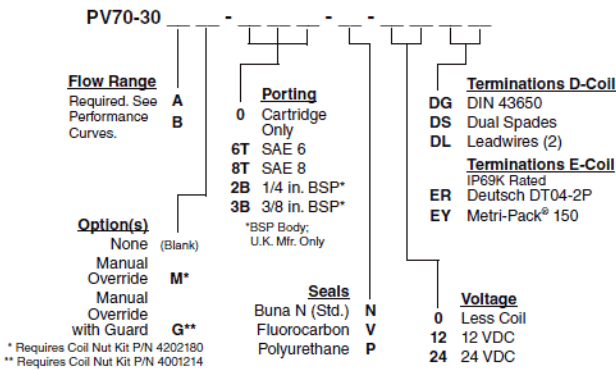

Model Options

PV70-30DE-H-J-L

D Max Regulated Flow

CODE	DESCRIPTION
A	30.3 lpm (8.0 gpm) Max Regulated Flow
B	17.0 lpm (4.5 gpm) Max Regulated Flow

E Manual Override

CODE	DESCRIPTION
BLANK	NONE



CODE	DESCRIPTION
------	-------------

G	Variable Position Override, Red Knurled Knob with Cover Cap
M	Variable Position Override, Red Knurled Knob

H Line Body

CODE	DESCRIPTION
0	No Body
6T	Aluminum SAE 6
8T	Aluminum SAE 8
6TD	Ductile Iron SAE 6
8TD	Ductile Iron SAE 8
3B	Aluminum BSPP 3/8" (3)
3BD	Ductile Iron BSPP 3/8" (3)

J Seal

CODE	DESCRIPTION
N	Buna-N
V	Fluorocarbon
P	Polyurethane
U	PPDI Urethane

L Coil

CODE	DESCRIPTION
0	No Coil
12DG	12 VDC, D-Coil, DIN 43650
12DL	12 VDC, D-Coil, Dual Lead Wires
12DL/W	12 VDC, D-Coil, Dual Lead Wires with Weatherpak
12DS	12 VDC, D-Coil, Dual Spade
12ER	12 VDC, E-Coil, Deutsch
12EY	12 VDC, E-Coil, Metri-Pack 150
24DG	24 VDC, D-Coil, DIN 43650
24DL	24 VDC, D-Coil, Dual Lead Wires
24DS	24 VDC, D-Coil, Dual Spade
24ER	24 VDC, E-Coil, Deutsch